

CSCE 463/612

Networks and Distributed Processing

Spring 2018

Transport Layer VI

Dmitri Loguinov

Texas A&M University

March 27, 2018

Original slides copyright © 1996-2004 J.F Kurose and K.W. Ross

Chapter 3: Roadmap

3.1 Transport-layer services

3.2 Multiplexing and demultiplexing

3.3 Connectionless transport: UDP

3.4 Principles of reliable data transfer

3.5 Connection-oriented transport: TCP

- Segment structure
- Reliable data transfer
- Flow control
- Connection management

3.6 Principles of congestion control

3.7 TCP congestion control

TCP Throughput

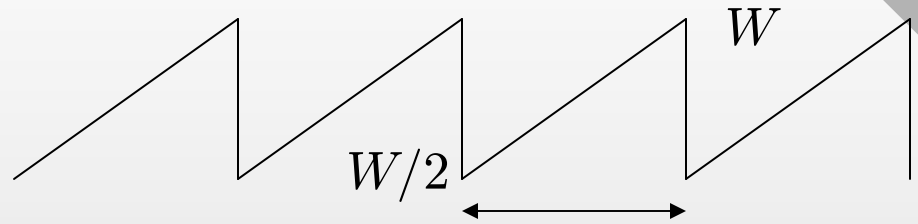

- What's the **average** throughput of TCP as a function of max window size W and RTT ?
 - Ignore slow start and assume perfect AIMD (no timeouts)
- Let W be the window size when loss occurs
- When window is W , throughput is $W * MSS / RTT$
- Just after loss, window drops to $W/2$, throughput to $W * MSS / (2RTT)$
- Average rate: $3/4 * W * MSS / RTT$

$$r_{av} = \frac{3}{4} \times \frac{W \times MSS}{RTT} = \frac{W_{av} \times MSS}{RTT}$$

TCP Model

- Example: 1500-byte segments, 100 ms RTT, want 10 Gbps average throughput r_{av}
 - Requires max window size $W = 111,111$ in-flight segments, 166 MB of buffer space ($W_{av} = 83,333$ packets)
 - But there are bigger issues as discussed below
- **Next**: derive average throughput in terms of loss rate
 - Assume packet loss probability is p
 - Roughly one packet lost for every $1/p$ sent packets
- Step 1: derive the number of packets transmitted in one oscillation cycle

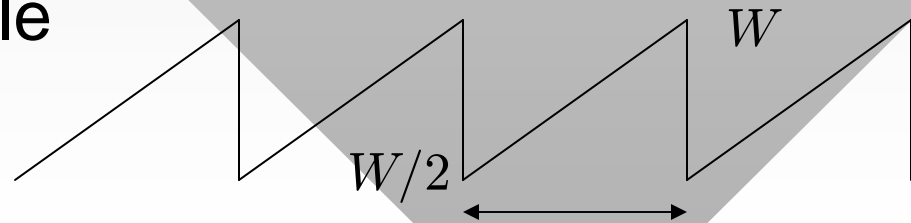

TCP Model

- Examine time in terms of RTT units
 - At each step, window increases by 1 packet
- The number of packets sent between two losses:

$$sent = \frac{W}{2} + \left(\frac{W}{2} + 1\right) + \left(\frac{W}{2} + 2\right) + \dots + W$$

- Combining $W/2$ terms, we have:

$$sent = \frac{W}{2} \left(\frac{W}{2} + 1\right) + \sum_{i=1}^{W/2} i$$

TCP Model

- Thus we arrive at:

$$sent = \frac{3}{8}W^2 + \frac{3}{4}W$$

- Step 2: now notice that this number equals $1/p$
- Ignoring the linear term, we approximately get:

$$\frac{1}{p} \approx \frac{3}{8}W^2$$

- In other words:

$$W = \sqrt{\frac{8}{3p}}$$

TCP Model

- Step 3: writing in terms of **average** rate:

$$r_{av} = \frac{W_{av} \times MSS}{RTT} = \frac{\frac{3}{4}W \times MSS}{RTT} = \frac{\frac{3}{4}\sqrt{\frac{8}{3p}} \times MSS}{RTT}$$

- Simplifying:

$$r_{av} = \frac{\sqrt{3/2} \times MSS}{RTT \sqrt{p}} \approx \frac{1.22 \times MSS}{RTT \sqrt{p}}$$

- This is the famous formula of AIMD throughput
 - Note: homework #3 does not use congestion control and its rate is a different function of p

TCP Model (Discussion)

$$\frac{1.22 \times MSS}{RTT \sqrt{p}}$$

- Example: What is the required packet loss for 100-ms RTT, 1500-byte MSS, and 10 Gbps average rate?
 - Turns out, $p = 2.1 \times 10^{-10}$, which is almost impossible (even in wired networks corruption occurs more frequently)
 - Backbone loss $p = 10^{-4}$ (and even 10^{-3}) is considered great
- Example: In AIMD, how long does it take for TCP to go from 5 Gbps average rate to 10 Gbps?
 - Window must grow from 41,666 pkts to 83,333
 - TCP needs $(83,333 - 41,666)$ RTTs to close this gap
 - This is 4,166 seconds = 1 hour 9 minutes
- Over long-distance links ($RTT > 50$ ms), AIMD typically maxes out around 200 Mbps

TCP Future

- TCP is slow, but what if most transfers are short?
 - How long before TCP reaches 10 Gbps in slow start?
- Idea: starting at $W = 1$ we need to reach $W = 83,333$ pkts at an exponential rate
- The time needed to reach full capacity is $\text{ceil}(\log_2(83333)) * RTT = 1.7$ seconds (17 steps)!
- How much data can we squeeze in slow start?

$$\text{pkts sent} = 1 + 2 + 4 + 8 + \dots + 2^{17} = 2^{18} - 1$$

- Total data transmitted (pkt size 1500) ≈ 393 MB
 - Conclusion: short connects are fine with current TCP

TCP Fairness

Fairness goal: if K TCP sessions share same bottleneck link of bandwidth C , each should have average rate of C/K

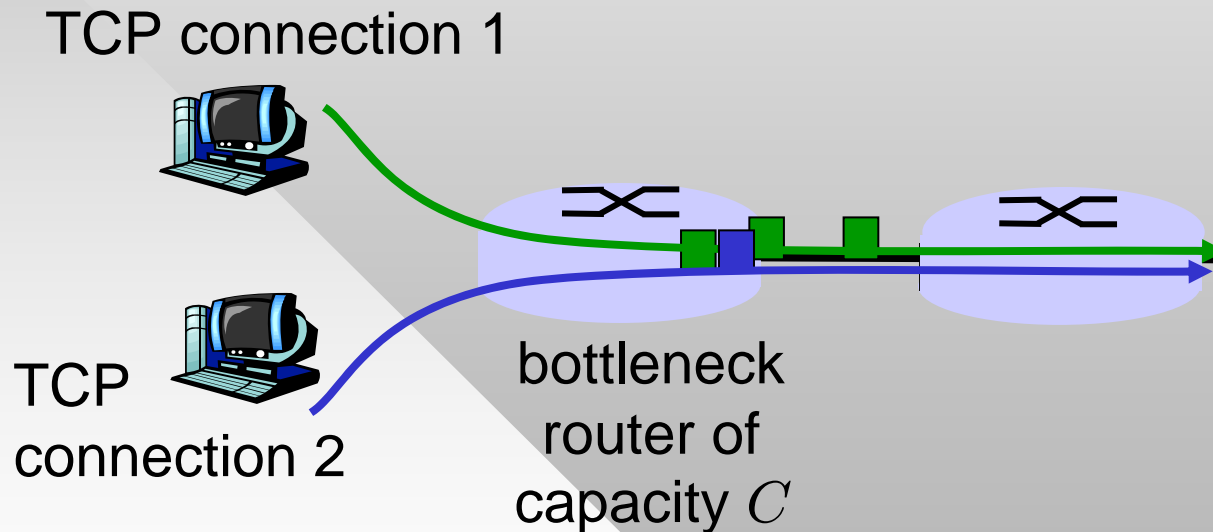

Fairness index of two flows: $\Phi = \frac{\min(x, y)}{\max(x, y)}$

TCP Fairness 2

- Fairness index = 1 is ideal since the rates are equal
- Fairness close to 0 indicates maximally unfair conditions
- Analysis using the **system trajectory plot**
 - Trajectory follows rates of flows x and y on a 2D plane
 - The plot connects points $(x(t), y(t))$, where t is time in RTT steps, $x(t)$ and $y(t)$ are the rates of the two flows

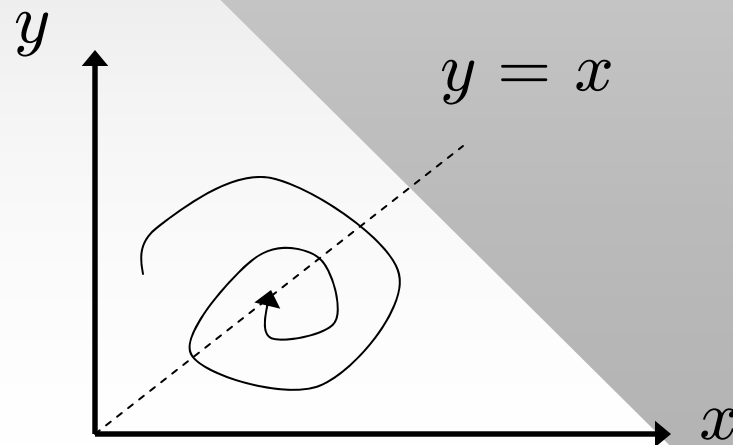

TCP Fairness 3

- Useful lines on this 2D plane
 - Fairness: $y = x$
 - Efficiency: $x + y = C$
 - Equi-fairness: $y = mx$
- Visual analysis
 - Which point(s) have packet loss?
 - Which point is more fair A or C ?

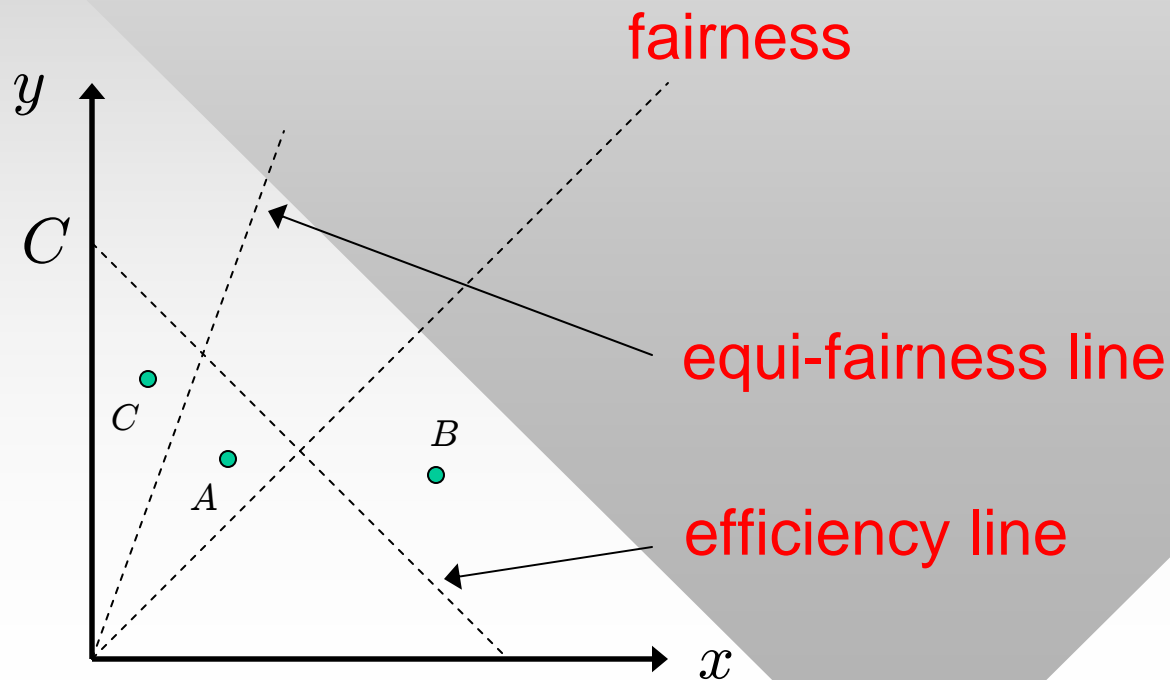

TCP Fairness 4

- The **fairness line** is where flow rates are equal
 - Hence, the goal is to converge the system to this line
- The **efficiency line** intersects both axes at C
 - When flows cross the efficiency line, they have loss
 - In uncongested cases, the system is below this line
- All points along the **equi-fairness line** have the same fairness index
 - Given initial flow rates (x, y) , rates $(\alpha x, \alpha y)$ have the same fairness index for any $\alpha > 0$

TCP Fairness 5

- Now examine what AIMD does (fixed MSS and RTT)
 - Start with **additive increase**
 - Why is this move parallel to the fairness line?
 - What happens to fairness?

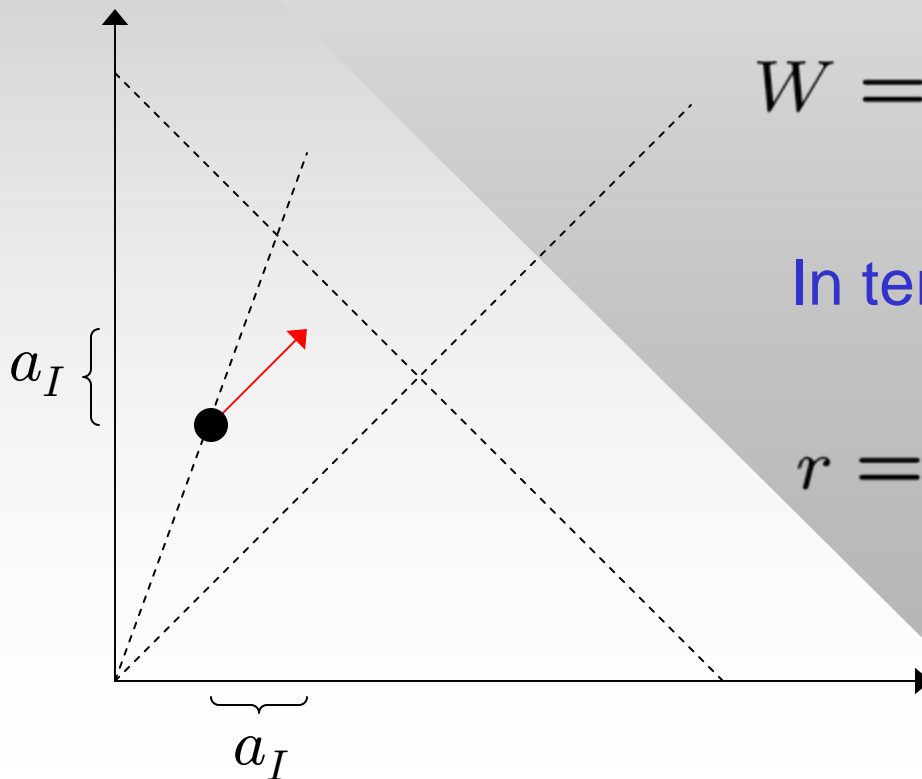

$$W = \begin{cases} W + 1 & \text{per RTT} \\ W/2 & \text{per loss} \end{cases}$$

In terms of rate:

$$r = \begin{cases} r + \frac{MSS}{RTT} & \text{per RTT} \\ r/2 & \text{per loss} \end{cases}$$

a_I

TCP Fairness 6

- Now consider **additive decrease**
 - Additive constant in the decrease step reduces fairness

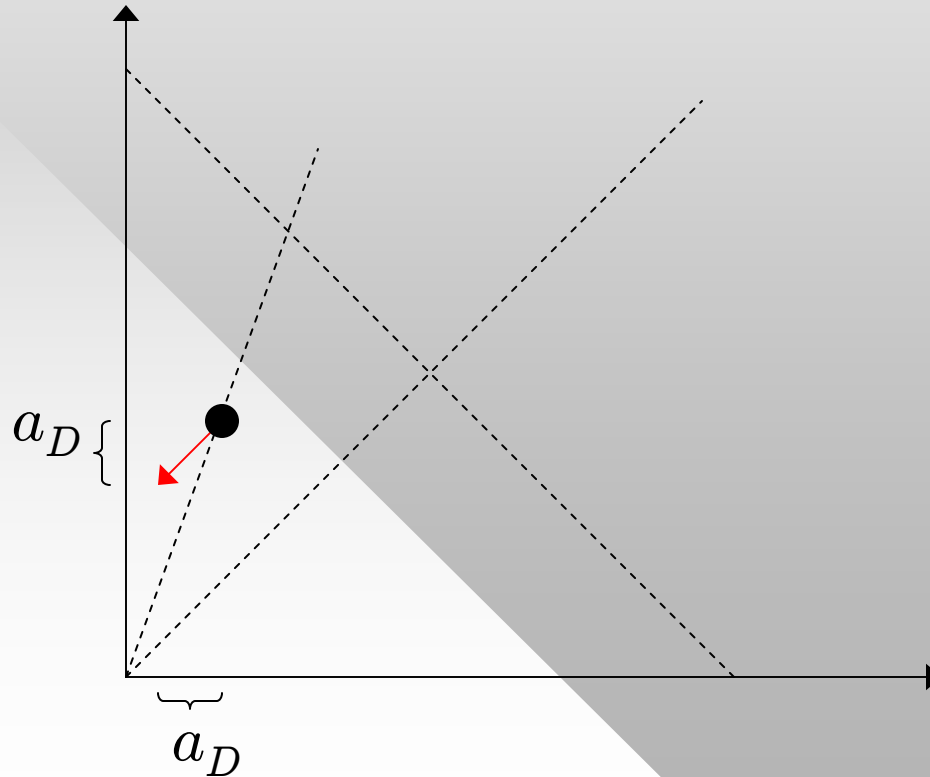

TCP Fairness 7

- Now examine a combination of additive increase and additive decrease (AIAD):
 - The system fluctuates between two fairness states without advancing towards the fairness line

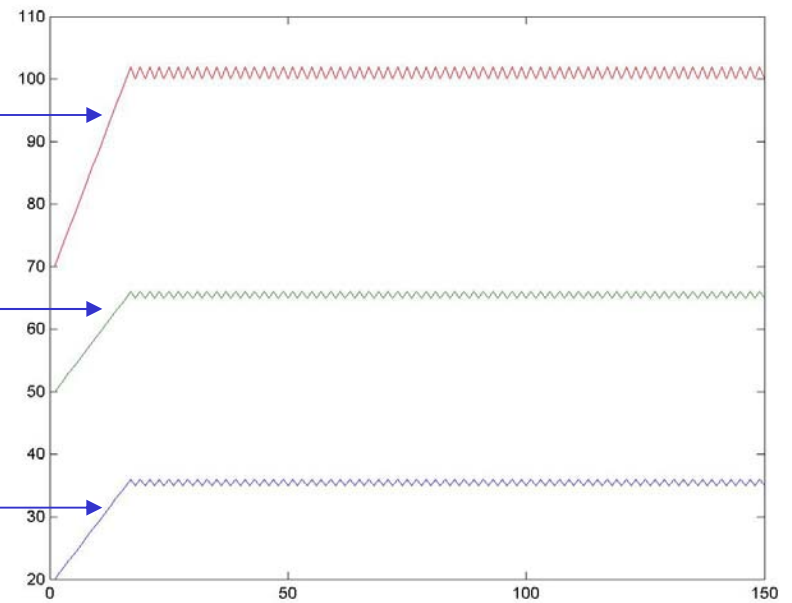
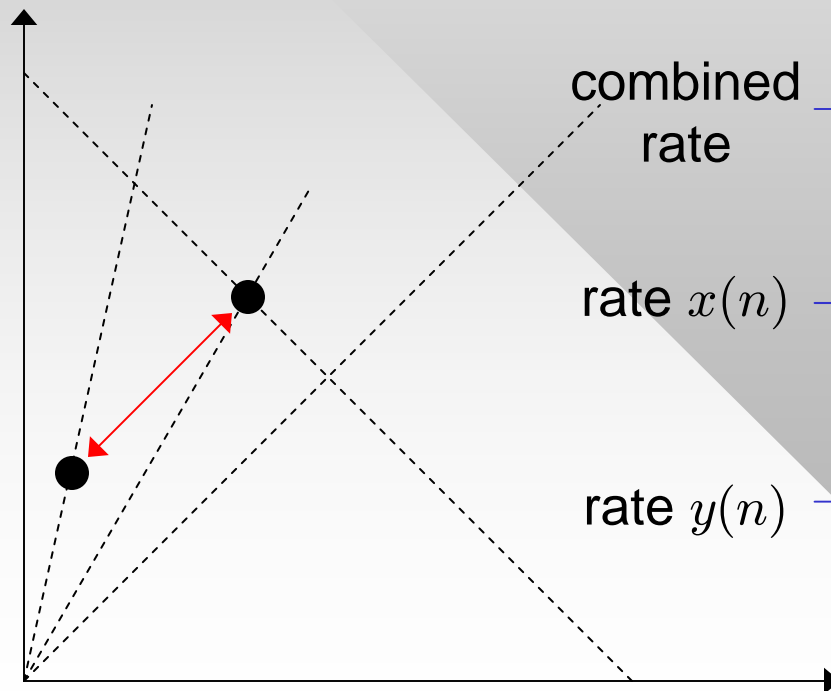

TCP Fairness 8

- Now examine MI (multiplicative increase) and MD (multiplicative decrease)

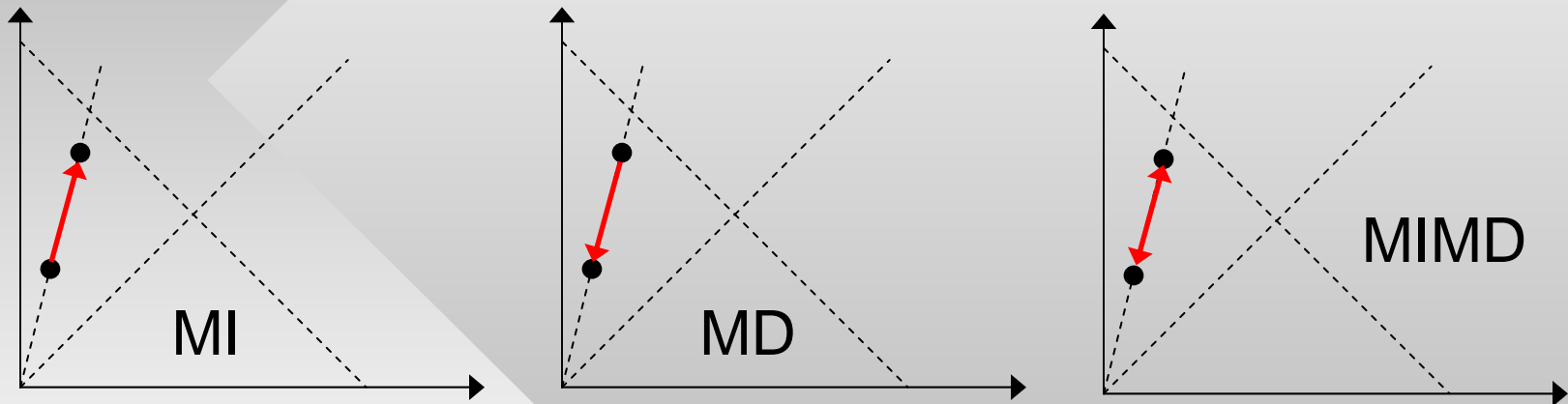

- What happens to fairness in each case?
- MIMD moves the system along the corresponding equi-fairness line
 - Does not converge to fairness either

Why Is TCP Fair?

Two competing sessions

- Assume initial rate y is lower, i.e., $x(0) > y(0)$:
- First consider the additive increase (AI) step
 - New rates:
$$x(n+1) = x(n) + MSS/RTT,$$
$$y(n+1) = y(n) + MSS/RTT$$
 - Prove that $\Phi(n+1) > \Phi(n)$
- Multiplicative decrease (MD)
 - New rates $x(n+1) = x(n)/2, y(n+1) = y(n)/2$
 - Prove that $\Phi(n+1) = \Phi(n)$

Why Is TCP Fair?

- Fairness stays the same during MD and improves during AI, eventually converging to 1
 - **Intuitive reasoning**: during increase, both flows gain bandwidth at the same rate; however, during decrease, the faster flow releases more

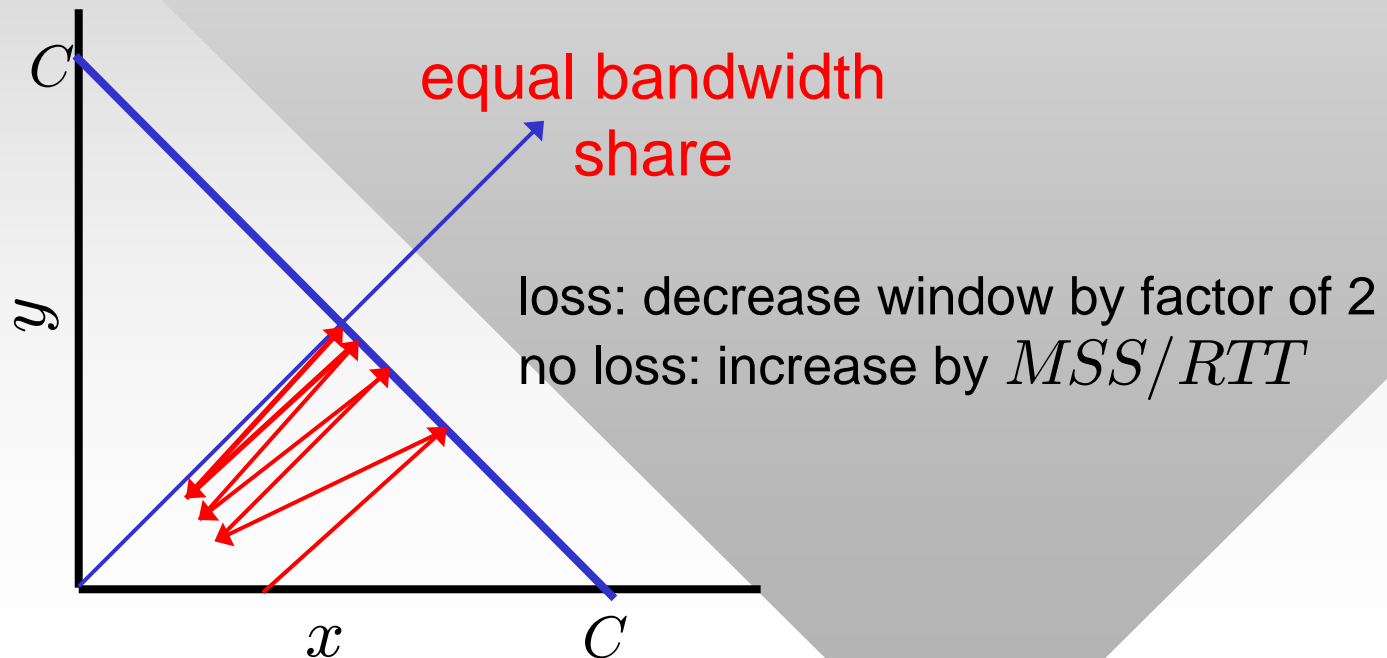

Fairness Example

- AIMD example
 - $C = 1544$ Kbps, 2 flows
- Start in the maximally unfair state
 - $x(0) = 1544, y(0) = 0$
- Eventually converge to fairness
- **Caveat:** fairness in TCP is achievable only when flows have the same RTT and MSS

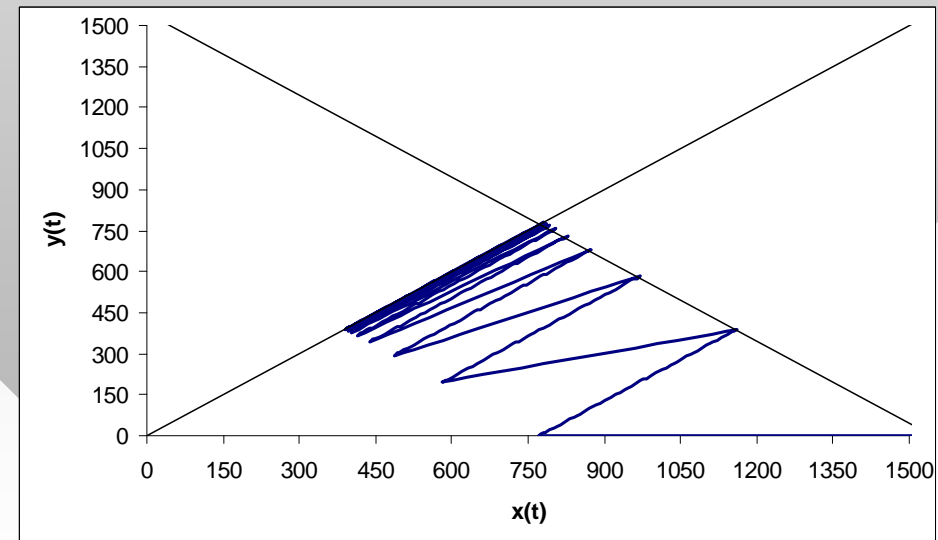
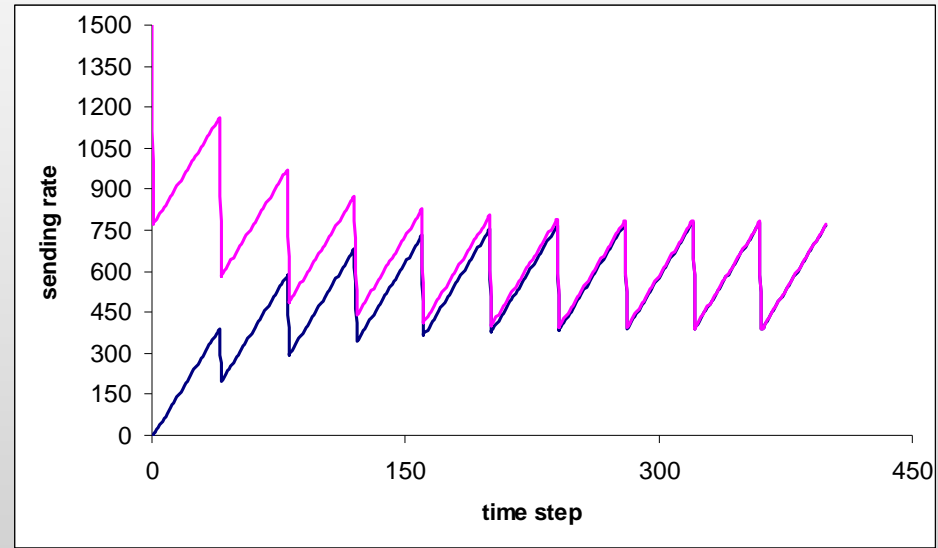

Fairness (Final Thoughts)

Fairness and UDP

- Multimedia apps often do not use TCP
 - Do not want rate throttled by congestion control
- Instead use UDP:
 - Pump audio/video at constant rate, tolerate packet loss
- Research area: TCP-friendly transport over UDP

Fairness and parallel TCP connections

- Nothing prevents app from opening parallel flows between 2 hosts
- Web browsers do this
- Example: link of rate C with 10 flows present:
 - New app asks for 1 TCP connection, gets rate $C/11$
 - New app asks for 10 TCPs, gets $C/2!$

Chapter 3: Summary

- Principles behind transport layer services:
 - Multiplexing, demultiplexing
 - Reliable data transfer
 - Flow control
 - Congestion control
- Instantiation and implementation in the Internet
 - UDP
 - TCP

Next:

- Leaving the network “edge” (application, transport layers)
- Into the network “core”